



**BD600 Series**  
High Performance Vector AC Drive

**Brochure**



## Introduction

BD600 series is latest version for high performance vector inverter based on BD330. Multiple control modes, New vector control algorithm can achieve stability at low speed, stronger load capacity at low frequency. Support SVC, VC and V/F control, and achieved using multiple PG cards. Stronger functions, functional of motor control has clearly raised.



## Features

### Outstanding performance

- 1) Large torque output when low frequency ;
- 2) Fast dynamic response ;
- 3) Super strong overload capacity

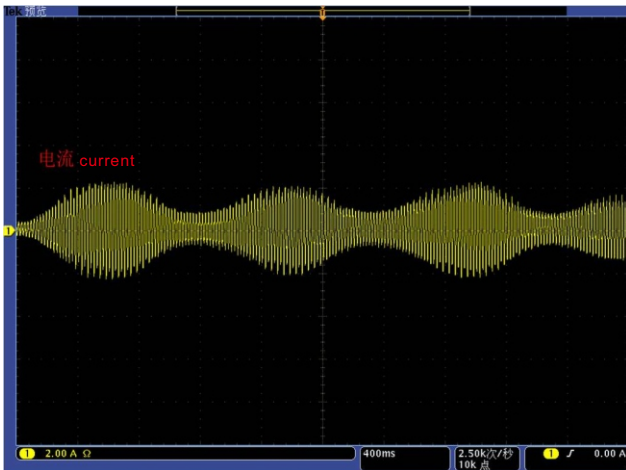

0.5Hz full-load output

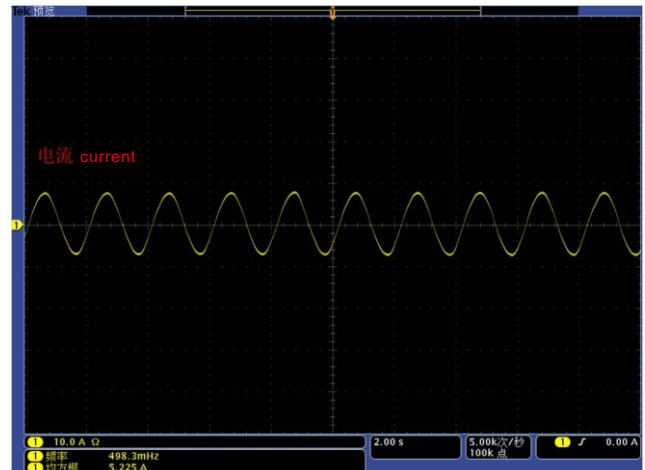

50Hz sudden load

### Accurate motor parameter self learning

BD600 series inverter can accurately provide dynamic or static self-learning of motor parameters, simple debugging, easy operating, higher control accuracy and response speed.

#### Dynamic self-learning

It need release the load, suitable for situation that requiring high control precision

#### Static self-learning

Applicable to the motor and load cannot release

## ■ Features

### ▶ Rapid current limit

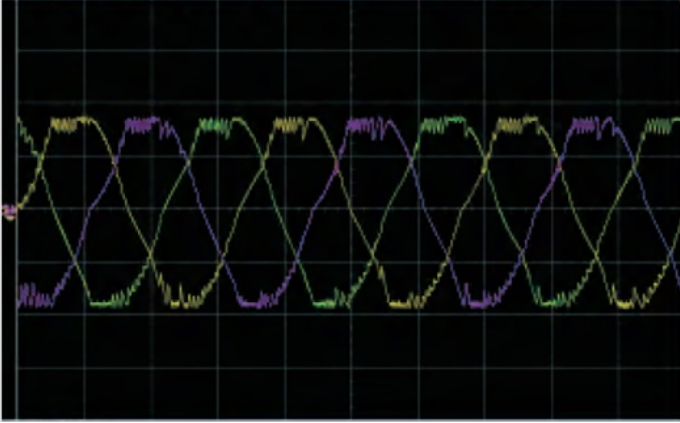

Rapid current limiting function can limit current rapidly within the current protection value, to ensure the safety of the equipment, and avoid over-current alarm caused by sudden loading or interference.

### ▶ Over-excitation gain and oscillation suppression gain

Over-excitation brake function valid

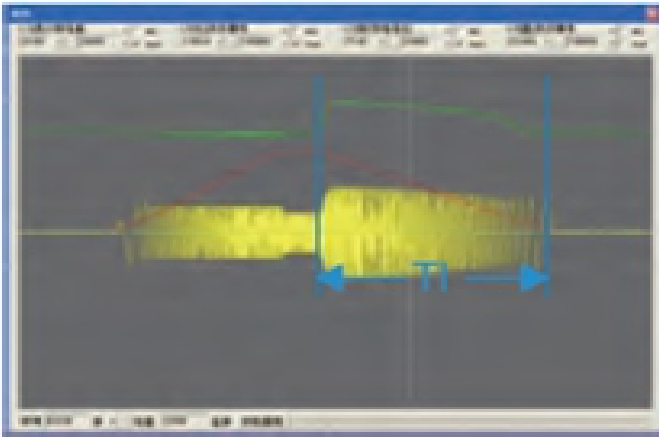

Over-excitation brake function invalid

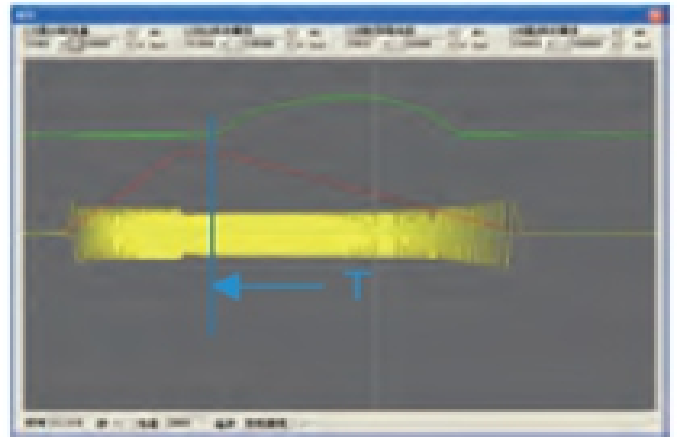

### ▶ Rapid RUN/STOP

Excellent current and voltage control technology can realize rapid RUN/STOP, restrain overvoltage and overcurrent.

### ▶ Overvoltage stall protection & Overcurrent stall protection

### ▶ Support both asynchronous motor and synchronous motor

- 1) asynchronous motor
- 2) synchronous motor (by using extension card)

## ■ Features

### ▶ Support multiple control mode

Speed sensorless vector control (SVC), sensor vector control (VC), V/F control

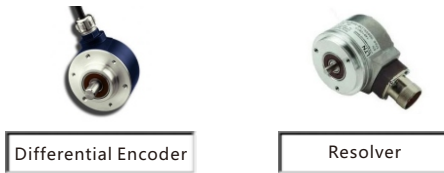

### ▶ Flexible and practical analog input/output

Each analog input (AI1 ~ AI3) can set 4 point curves.

### ▶ High-speed pulse input and output functions

High speed pulse signal specification: voltage range 9V~26V, frequency range 0 ~ 100 KHZ. Can setting 2 pint curves, high control precision. HDI/HDO high speed pulse input/output terminal can be used for DI/DO.

### ▶ Swing frequency control function

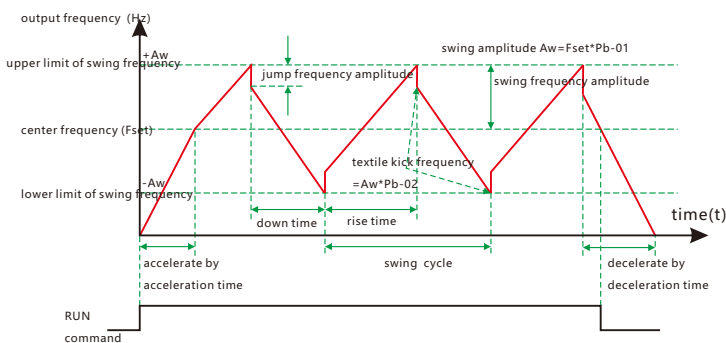

### ▶ Frequency source binding & compose

Run command source are free to bind any frequency source. 10 kinds of main-auxiliary frequency source, flexible to adjust and compose.

For example: A+B, A-B, AB switch, etc

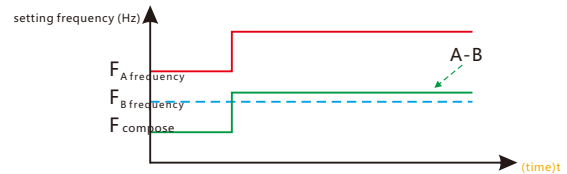

### ▶ None-stop when instantaneous power off

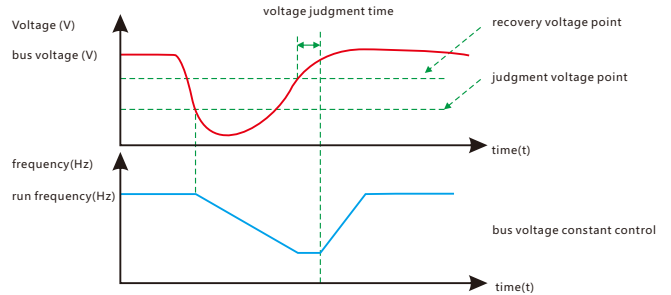

### ▶ Simple PLC

### ▶ Multiple motor switch

Two groups of motor parameters, and control two motors by one inverter.



## ■ Technical Features

LR Features	lqsxwYr oadj h Udqj h	4DF553Y648 / 3AC220VÑ15 / 3AC380VÑ15 / 3AC660VÑ10 / 3AC1140VÑ15		
	lqsxwLht xhqf   Udqj h	7: Ø6K}		
	RxvswYr oadj h Udqj h	3Qvshg lqsxwYr oadj h		
	RxvswLht xhqf   Udqj h	3Q933K}		
LR Terminals	lqsxwWhup lqdø	<p>β9 sur j udp p deð glj lwdlqsw/lwf dq eh h{vraqghg w 7 glj lwdlqsw/r qh ri z klf k vxssr uw high speed pulse input;</p> <ul style="list-style-type: none"> <li>• 1 analog volatge input, -10~10VDC;</li> <li>• 2 volatge input 0~10VDC or current input 0~20mA</li> </ul>		
	RxvswWhup lqdø	<p>β4 r shq f r ðif wur vxswlwlf dq eh h{vraqghg w 4 klj k vshhg sxøh r vxsw&gt;</p> <ul style="list-style-type: none"> <li>• 2 relay outputs;</li> <li>• 2 analog output: volatge output 0~10VDC or current output 0~20mA</li> </ul>		
UXQ	Pxalsð hqf r ghuvshv	Dyduhv ri hqf r ghulv r svr qdøvxssr uagliihqvlðohqf r ghul DE  hqf r ghulXYZ hqf r ghul ur vduj transformer		
	F r qwr oPrgh	Vshhg vhaqr uðvv yhf wuf r qwr o+YF, / vhaqr uyhf wuf r qwr o+YF, / Y2 f r qwr o		
	I lht xhqf   Uhihuhqf h Vr xuf h	Glj lwdlqsdø j /sxøh iuh xhqf   /vhduð r p p xqlf dvr q/p xalðvns vshhg/vlp sð SCF dqg SIG/ The combination of multi-modes and the different modes can be switched.		
	Ryhwdg F dsdf lþ	<p>βJ ψsh=93v ir u483( ri vkh uðvng f xuhqw6v ir u4; 3( ri vkh uðvng f xuhqw</p> <ul style="list-style-type: none"> <li>• P type: 60s for 120% of the rated current, 3s for 150% of the rated current</li> </ul>		
	VvluwWf ut xh	<p>βJ ψsh=3B K} 283( +YF, &gt;3 K} 2; 3( +YF,</p> <ul style="list-style-type: none"> <li>• P type: 0.5 Hz/100%</li> </ul>		
	Vshhg Dgrvvlaj Udqj h	4=433 +YF,	4=4333 +YF,	
	Vshhg Df f xudf	è3B( SVC)	è3B5( VC	
	F duhuLht xhqf	3B w 49BnK} æxwv dvl dð dgrvvl duhuLht xhqf   df f r ugqj w vkh ø dg f kdudf vluwv v		
	Uhrvæwq ri l lht xhqf   vhwaj	Glj lwdlvhwaj æ3B4K} Dqr ø j vhwaj æ d{lp xp iuh xhqf   { 3B58(		
Uxqqqaj f r p p dqg vr xuf h	<p>βNhl er dug</p> <ul style="list-style-type: none"> <li>• Control terminals</li> <li>• Serial communication port</li> </ul>			
I xqf vlr qv	Wf ut xh Err v w	Dxwv dvl w ut xh er r vwp dxdow ut xh er r vwb4Q63(		
	Y2 f xuyh	<p>βVudlj kvatqh Y2 f xuyh</p> <ul style="list-style-type: none"> <li>• Multi-point V/F curve</li> <li>• Square V/F curve</li> <li>• V/F complete separation</li> <li>• V/F half separation</li> <li>• N-power V/F curve (1.2-power, 1.4-power, 1.6-power, 1.8-power)</li> </ul>		
	Df f Zshf Prgh	Vudlj kvatqh r uVf xuyh Four kinds of acceleration/deceleration time with the range of 0.0 –6500.0s		
	GF Eudnlaj	<p>Vxssr uw vvlulaj dqg vwrslaj GF eudnlaj</p> <ul style="list-style-type: none"> <li>• DC braking frequency: 0.00 Hz to maximum frequency</li> <li>• Braking time: 0.0–100.0s</li> <li>• Braking action current value: 0.0%–100.0%</li> </ul>		
	Mj j lqj f r qwr o	Mj iuh xhqf   udqj h=3BK} w 83K} >Mj Df f Zshf vlp h=3Q9833Bv		
	Vlp sð SCF dqg Pxalðvshg rshudv r q	Exludq SCF r uf r qwr vluw lqdø49 vns vshhg f dq eh vhw Hold time and acceleration/deceleration of each step speed can be adjusted		
	Exludq SIG	Hdv   w uhdð h f øvhgø r s f r qwr ov   vluw ir uvk h sur f hvv f r qwr o		
	Dxwv dvl yr oadj h thj xalv r q+DYU,	Dxwv dvl dð p dlqvlq d f r qvudqwr vxswYr oadj h z khq vkh yr oadj h ri hðif wlf lþ j ug f kdaj hv		
	Vws p rgh vðif vlr q	<p>βGhf hðudv w vws</p> <ul style="list-style-type: none"> <li>• Coast to stop</li> </ul>		
	Wf ut xh ðp lwdqg f r qwr o	ð{f dydwuf kdudf vluw dxwv dvl ðp lww ut xh z khq uxqqqaj f dq suhyqwr yhuð xuhqwms f r qlvxdð > Vector mode can realize torque control		
	Pxalð r wuvz lþkr yhu	Ht xls z lþ v r j ur xsv ri p r wusdudp hluw lwf dq uhdð h vz lþklaj f r qwr ori v r p r wuw		
	Vz lþkr yhuixqf vlr q	Wf vto43 p dlq dqg dx{lddu iuh xhqf   vr xuf h1Wkh  f dq eh vz lþkhg dqg f r p elqhg ið{leð		

## ■ Technical Features

Vz lqj iuht xhqf   f r qwr aixqf vlr q	Pxalsdn vldqj xadusxoh iuht xhqf   f r qwr o
F r p p r q GF exv ixqf vlr q	Pxalsdn lqyhulur f dq xvhd f r p p r q GF exv
Vshhg wdf nlqj ixqf vlr q=	Pxalsdn vshhg wdf h p r gh/ vkh vshhg r i wdf h f dq eh dgxvvlqg
Vlp lqj f r qwr o	Vlp lqj vhwkqj udqj h 3C9833p lq
I l f hg dngj vkr	vhwkqj dngj vkr f r qwr o
Mkp s iuht xhqf   ixqf vlr q	Suhyhqw p hf kdqf douvr qdqf h dqg p dnhv vkh v l vlap p r th vvaldn dqg uhdndn
Sur vnf vlr q ixqf vlr q	Ryhuvr dnyh sur vnf vlr q/ xqghuwr dngj h sur vnf vlr q/ r yhuvr xuhqvsur vnf lwrq/ r yhuvr dg sur vnf vlr q/ r yhuvr dngj protection, overcurrent stall protection, overvoltage stall protection, phase-loss protection, over-speed detection, motor overheat protection, short-circuit protection.
Rvkhuixf vlr qv	<p>βSdudp hmluuhvruh</p> <ul style="list-style-type: none"> <li>• Parameter self-learning</li> <li>• PID parameters switchover</li> <li>• PID feedback loss detection</li> <li>• Over-torque and under-torque detection</li> <li>• None-stop when instantaneous power off                             <ul style="list-style-type: none"> <li>• Sleep and wake function, etc.</li> <li>• Rapid current limit</li> </ul> </li> <li>• Current detection compensation                             <ul style="list-style-type: none"> <li>• Fault self-recovery</li> </ul> </li> <li>• Backup data for power fail of simple PLC</li> </ul>
F r p p xqf dvr qv	UV7; 8
H{ vhwkqj r f dngj	I2R h{ vhwkqj r f dngj/ S J f dngj +Uhd} h{ vhwkqj r f dngj dqg Y2 h{ vhwkqj r f dngj eh f xvwrp l} hg dv   r xuht xhvvt
SFE f r dngj	lp sr ulng f r qir up dosur vnf vlyh f r dngj
Glvsdl	CHG Glvsdl   F dq glvsdl =vhwkqj iuht xhqf   r xvswiut xhqf   r xvswyr dngj h r xvswf xuhqwhv 1
Sur vnf vlr q dnyho	IS53
Vhp vlap shudvruh	043 ~+40 it will be derated if ambient emperature exceeds 40
Kxp lglv	Ehaz <3( UK -qr f r qghqvdlr q,
Yleudvr q	±20Hz 9.8m/s(1G), M20Hz 5.88m/s(0.6G)
Dolxgh	Ehaz 4333p /lqgr r usdlf h z lkr xwf r ur vlyh j dv/ dt xlg,
Vvudj h vhp shudvruh	053 ~+60

### ● Inverter nameplate:

MODEL: BD600-3R7G/5R5P-4	Specification and model
INPUT: 3PH 380V 50/60Hz	Input
OUTPUT: 3PH 0-380V 0-600Hz	Output
POWER: 3.7/5.5kW 8.5/13A	Power
S/N: 	Bar code
01B3413A115251001	Serial number
ZHEJIANG NEW FOLINN ELECTRIC CO.,LTD	

### ● Specifications and models:

**BD600 - 3R7G/5R5P - 4 - XX**

- Technology version
- Input voltage classes: 2:220V 4:380V 6:660V 7:1140V
- Specifications and models: Heavy load 3.7kW, Light load 5.5kW
- Serial code:BD600 Series

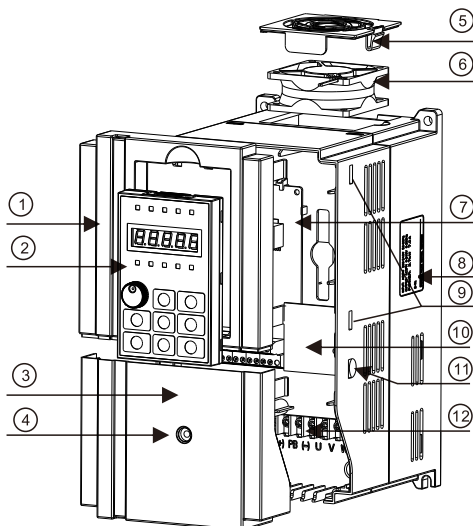

No.	Name	Description
①	Pre-cover	Used for install display keyboard and protect components
②	Keyboard	Used for amend and check inverter parameters, operation and other functions
③	Tail-hood	
④	Retaining screw of tail-hood	Used to fix tail-hood, and loosen this screw first while disassembly
⑤	Snap joint of fan	Used to fix fan, convenient to disassembly
⑥	Cooling fan	Internal heat dissipation of inverter
⑦	Control board	CPU board of inverter
⑧	Nameplate	
⑨	Snap joint of pre-cover	Used to fix pre-cover, total four on both left and right
⑩	Expansion board	Built-in multifunctional expansion board
⑪	Snap joint of tail-hood	Used to fix tail-hood, one on both left and right
⑫	Main loop terminal	

## Basic wiring diagram

### Basic wiring diagram

- ⊙ Main circuit terminal
- Control circuit terminal

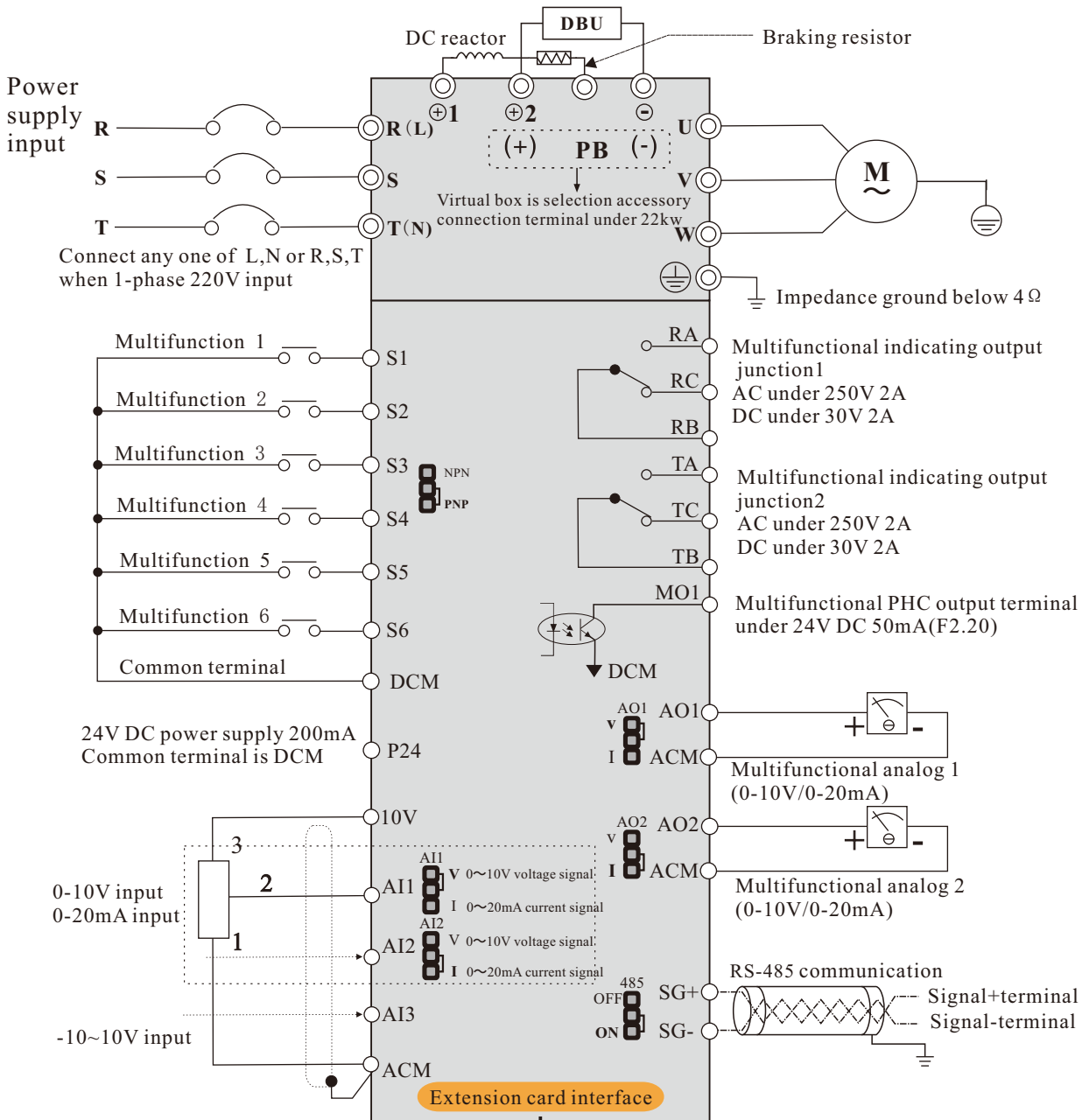

Extension card: I/O extension card, PG card  
(Relay extension card and V/I extension card can be customized as your request.)

**Notes:** The general type inverters of 22KW and below have built-in brake unit, brake resistance (+) and PB terminal; (+) and (-) terminals are the plus or minus terminals of inverter's DC bus. Reserved direct current reactor connection terminals above 22KW, ⊕1 ⊕2, ⊕2 and ⊖ terminals are used to connect energy feedback unit or brake unit. When brake unit is used in high-power inverters, you shall connect positive pole of brake unit to output terminal ⊕2 of direct current reactor. If it is connected to ⊕1 terminal, it will damage brake unit.

## ■ Model Selection

Models	Rated power (kW)	Rated input current (A)	Rated output current (A)	Adaptive motor (KW)
Input 1PH 220V±15% 47Hz~63Hz				
BD600-0R4G-2	0.55	5.4	4.0	0.55
BD600-0R7G-2	0.75	8.2	5.0	0.75
BD600-1R5G-2	1.5	14.0	7.0	1.5
BD600-2R2G-2	2.2	23	10.0	2.2

Models	Rated power (kW)	Rated input current (A)	Rated output current (A)	Adaptive motor (KW)
Input 3PH 220V±15% 47Hz~63Hz				
BD600-0R5G-2	0.55	3.8	3.2	0.55
BD600-0R7G-2	0.75	4.9	4.1	0.75
BD600-1R5G-2	1.5	8.4	7.0	1.5
BD600-2R2G-2	2.2	11.5	10.0	2.2
BD600-3R7G-2	3.7	18	15	3.7
BD600-5R5G-2	5.5	24	23	5.5
BD600-7R5G-2	7.5	37	31	7.5
BD600-011G-2	11	52	45	11
BD600-015G-2	15	68	58	15
BD600-018G-2	18.5	84	71	18.5
BD600-022G-2	22	94	85	22
BD600-030G-2	30	120	115	30
BD600-037G-2	37	160	145	37
BD600-045G-2	45	198	180	45
BD600-055G-2	55	237	215	55
BD600-075G-2	75	317	283	75

## ■ Model Selection

Models	Rated power (kW)	Rated input current (A)	Rated output current (A)	Adaptive motor (KW)
Input 3PH 380V±15% 47Hz~63Hz				
BD600-0R7G/1R5P-4	0.75/1.5	3.4/5.0	2.5/3.7	0.75/1.5
BD600-1R5G/2R2P-4	1.5/2.2	5.0/5.8	3.7/5.0	1.5/2.2
BD600-2R2G/3R7P-4	2.2/3.7	5.8/10.5	5.0/8.5	2.2/3.7
BD600-3R7G/5R5P-4	3.7/5.5	10.5/14.6	8.5/13	3.7/5.5
BD600-5R5G/7R5P-4	5.5/7.5	14.6/20.5	13/18	5.5/7.5
BD600-7R5G/011P-4	7.5/11	20.5/26	18/24	7.5/11
BD600-011G/015P-4	11/15	26/35	24/30	11/15
BD600-015G/018P-4	15/18.5	35/38.5	30/37	15/18.5
BD600-018G/022P-4	18.5/22	38.5/46.5	37/46	18.5/22
BD600-022G/030P-4	22/30	46.5/62	46/58	22/30
BD600-030G/037P-4	30/37	62/76	58/75	30/37
BD600-037G/045P-4	37/45	76/92	75/90	37/45
BD600-045G/055P-4	45/55	92/113	90/110	45/55
BD600-055G/075P-4	55/75	113/157	110/150	55/75
BD600-075G/093P-4	75/93	157/180	150/170	75/90
BD600-093G/110P-4	93/110	180/214	170/210	90/110
BD600-110G/132P-4	110/132	214/256	210/250	110/132
BD600-132G/160P-4	132/160	256/307	250/300	132/160
BD600-160G/200P-4	160/200	307/385	300/380	160/200
BD600-200G/220P-4	200/220	385/430	380/430	200/220
BD600-220G/250P-4	220/250	430/468	430/465	220/250
BD600-250G/280P-4	250/280	468/525	465/520	250/280
BD600-280G/315P-4	280/315	525/590	520/585	280/315
BD600-315G/350P-4	315/350	590/665	585/650	315/350
BD600-350G/400P-4	355/400	665/785	650/754	350/400
BD600-400G/500P-4	400/500	785/965	754/930	400/500
BD600-500G/630P-4	500/630	965/1210	930/1180	500/630
BD600-630G/710P-4	630/710	1210/1465	1180/1430	630/710

## External Dimension

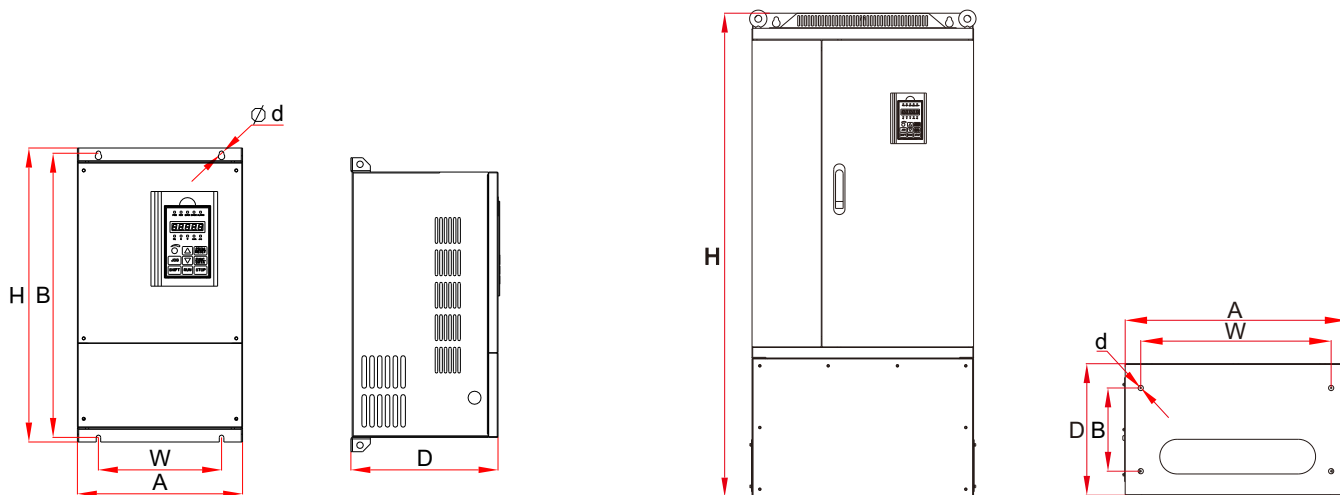

Wall-mounted housing

Wall-mounted/ Floor combination housing

Base NO.	Model	Power(kW)	Dimensions(mm)						Housing
			A(width)	H(height)	D(depth)	W	B	d	
B10	BD600-0R5G-2	0.55kW	116	175	153	103	165	5	wall mounted plastic housing
	BD600-0R7G-2	0.75kW							
	BD600-1R5G-2	1.5kW							
B01	BD600-2R2G-2	2.2kW	134	251	173	121	238	5	
	BD600-3R7G-2	3.7kW							
B02	BD600-5R5G-2	5.5kW	161	274	198	148	261	6	
	BD600-7R5G-2	7.5kW							

Base NO.	Model	Power(kW)	Dimensions(mm)						Housing
			A(width)	H(height)	D(depth)	W	B	d	
B10	BD600-0R7G/1R5G-4	0.75kW	116	175	153	103	165	5	wall mounted plastic housing
	BD600-1R5G/2R2G-4	1.5kW							
	BD600-2R2G/3R7G-4	2.2kW							
B01	BD600-3R7G/5R5G-4	3.7kW	134	251	173	121	238	5	

Note: B10 housing can not support PG card and extension card.  
If need to add, please use B01 housing.

## External Dimension

Base NO.	Model	Power(kW)	Dimensions(mm)						Housing
			A(width)	H(height)	D(depth)	W	B	d	
B02	BD600-5R5G/7R5P-4	5.5kW	161	274	198	148	261	6	wall mounted plastic housing
	BD600-7R5G/011P-4	7.5kW							
B03	BD600-011G/015P-4	11kW	210	343	215	195	327	6	
	BD600-015G/018P-4	15kW							
B11	BD600-018G/022P-4	18.5kW	220	393	222	160	377	6	
	BD600-022G/030P-4	22kW							
B04	BD600-030G/037P-4	30kW	255	453	237	190	440	7	
	BD600-037G/045P-4	37kW							
B05	BD600-045G/055P-4	45kW	280	582	295	200	563	9	
	BD600-055G/075P-4	55kW							
B06	BD600-075G/093P-4	75kW	300	685	323	200	667	11	wall mounted steel casing housing
	BD600-093G/110P-4	93kW							
B07	BD600-110G/132P-4	110kW	420	840	334	150*150	815	11	
	BD600-132G/160P-4	132kW							
	BD600-160G/200P-4	160kW							
B09	BD600-200G/220P-4	200kW	640	1035	390	250*250	1003	11	
	BD600-220G/250P-4	220kW							
	BD600-250G/280P-4	250kW							
	BD600-280G/315P-4	280kW							
	BD600-315G/350P-4	315kW							
B07-G	BD600-110G/132P-4	110kW	420	1108	334	320	230	12	Floor type steel casing housing
	BD600-132G/160P-4	132kW							
	BD600-160G/200P-4	160kW							
B09-G	BD600-200G/220P-4	200kW	640	1400	390	550	240	15	
	BD600-220G/250P-4	220kW							
	BD600-250G/280P-4	250kW							
	BD600-280G/315P-4	280kW							
	BD600-315G/350P-4	315kW							

## Optional extension cards

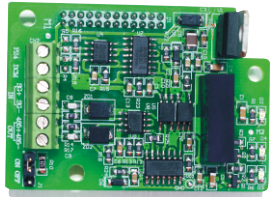
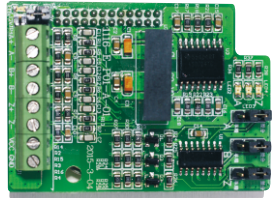
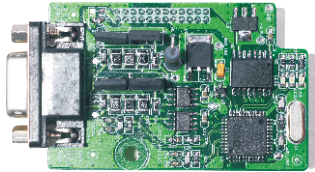
RS485 communication card		Differential encoder PG card		Resolver PG card	
(BD-RS485)		(BD-PG03)		(BD-PG04)	

## Optional brake unit and brake resistance

Voltage	AC Drive power	brake unit		brake resistance			brake torque (10%UD)
		model	pcs	power(W)/resistance(Ω)	pcs		
220V	0.55kW	built-in	-	80	120	1	100%
	0.75kW		-	80	120	1	
	1.5kW		-	150	100	1	
	2.2kW		-	300	68	1	
	3.7kW		-	300	68	1	
	5.5kW		-	400	30	1	
	7.5kW		-	400	30	1	
380V	0.75kW		-	150	300	1	
	1.5kW		-	200	300	1	
	2.2kW		-	200	200	1	
	3.7kW		-	400	150	1	
	5.5kW		-	400	100	1	
	7.5kW		-	750	75	1	
	11kW		-	1000	60	1	
	15kW	-	1500	40	1		
	18.5kW	-	2500	30	1		
	22kW	-	3000	30	1		
	30kW	DBU-4030	1	5000	25	1	
	37kW	DBU-4045	1	7500	20	1	
	45kW		1	10000	13.6	1	
	55kW	DBU-4030	2	5000*2	25	1	
	75kW	DBU-4045	2	7500*2	15	1	
	93kW		2	10000*2	13.6	1	
	110kW	DBU-4160	1	20000	8	1	
132kW	1		25000	6	1		
160kW	1		30000	6	1		
200kW	1		35000	4.5	1		
220kW	1		40000	4.5	1		
250kW	DBU-4280	1	45000	4	1		
280kW		1	50000	3.5	1		
315kW		1	55000	3	1		
350kW		1	60000	2.5	1		
400kW		1	60000	2.5	1		
450kW		1	80000	2	1		

## ■ Other Products

### ▶ Low Voltage Inverters

- BD600 Series High Performance General Purpose Inverters
- BD330 Series High performance general purpose Inverters
- DZB200M Series Mini Economy Inverters
- DZB300 Series general purpose Inverters
- BD550 Series High Performance Vector Control Inverters
- BD570 Series High Performance Tri-level Inverters
- BD1000 Series High Performance Vector Control Inverters
- BD331 Series Special Inverters For pump Water Supply
- BD332 Series Special Inverters For Injection Machine
- BD333 Series Special Inverters For Textile Machine
- BD335 Series Special Inverters For dual-motor centrifugal machine
- BD336 Series open structure type inverters
- BD337 Series High-performance Inverters (IP53)
- BD338 Series Special Inverters For rotary cutter
- BD339 Series Special Inverters For air-compressor
- BD340 Series Special Inverters For variable-frequency power
- BD341 Series Special Inverters For Pile Machine
- DZB312 Series Special Inverters For Carving Machine (CNC Router)
- BD380 Series special for Injection Molding Machine
- BD381 Series special for Pumping Unit
- BD382 Series special for Frame Saw Machine
- BD383 Series special for Power source
- BD385 Series special for Molecular Pump Power Source

### ▶ Servo Drive System

- FS100 Series General-Purpose AC Servo
- FS110 Series General-Purpose AC Servo
- FS600 Series General-Purpose AC Servo
- FS200 Series PMSM Hydraulic System
- FS300 Series AC Asynchronous System
- FS510 Series PMSM Special For Air-Compressor

### ▶ Medium Voltage Inverters

- DZB10HV Series Medium Voltage Inverters
- DZB20HV Series Medium Voltage Inverters

### ▶ Others

- PFU100 Series High Performance General Energy Feedback Unit
- PFU110 Series High Performance Energy Feedback Unit
- DBU100 Series Braking Unit
- EH100 Series Small Power Electromagnetic Heating Controller



China Top 10 Brand of Low-voltage Inverter

CEEIA Council Member of Inverter Industry

First Medium-voltage Inverter Manufacturer in Zhejiang

National Torch Program Item

Zhejiang High-tech Enterprise

Zhejiang Famous Brand



ZHEJIANG NEW FOLINN ELECTRIC CO. , LTD  
Add: No. 2 Jinhuan Road, Chengbei Street, Wenling City, Zhejiang, China  
Tel: +86-576-86421218  
Fax: +86-576-86421168

[www.chinafolinn.com](http://www.chinafolinn.com)

